

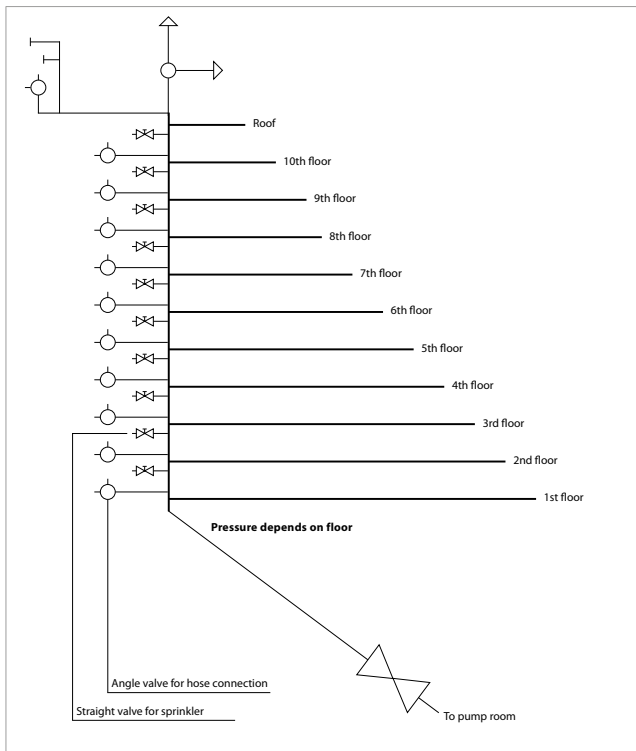

**Description**

The field adjustable pressure reducing valve. Range for installations where pressure must be controlled at different floors, either for standpipe or sprinkler systems. To better understand the installation of the pressure reducing valve, we would like to refer to the following example of installation.



The design of sprinkler and standpipe systems for high-rise buildings often creates pressures at some locations in the building that exceeds 200 PSI. For standpipe systems, lesser pressure may be required at hose valves by NFPA 14, local fire departments and/or the design needs of certain hoses and nozzles. For sprinkler systems, NFPA 13 and the needs of particular equipment also require lesser pressure.

The straight valves (A203, A204) have the inlet and outlet in a straight line; the inlet is indicated by an arrow.

The angle valves (A201, A202) have the inlet on the lower part indicated by an arrow. The outlet is at an angle of 90°.

The valves are available with male female threads according to the requested use. All valves have two 1/4" side taps for upstream and downstream pressure gauges.

**Versions and product codes**

Series	Size	Type
A201	2 1/2" x 2 1/2"	Double female - Angle
A202	2 1/2" x 2 1/2"	Female x Male hose thread - Angle
A203	2 1/2" x 2 1/2"	Double female - Straight
A204	2 1/2" x 2 1/2"	Female x Male hose thread - Straight

**Operating**

The valves are capable of adjustment to provide a range of the outlet pressures and flowrates. The valves may first be installed, and then adjusted for pressure and flowrate.

**Advantages**

Only one kind of valve for every floor. No error in the installation, as every valve is adjustable. Valves should be installed by qualified personnel only.

**Technical data**

- Maximum inlet pressure: 400 psi
- Outlet pressure range: 65-175 psi

**Materials**

- Body: casted bronze
- Handwheel: aluminum
- Spring: stainless steel
- Gasket: NBR rubber

**Approvals**



**Determining the proper outlet pressure**

1- According to UL 1468 issue December 4, 2007, "A valve intended for standpipe system outlets shall be constructed to incorporate a setting or settings to provides static outlet pressures not exceeding 175 psi (1219 kPa) for 2-1/2" inch outlets and residual outlet pressures at the flow specified in Table 9A.1 of the above mentioned Standard. That means the following Residual outlet pressure, psi @ flowrate ≥65 and ≤175 at less than or equal to 250 gpm.

2- For sprinkler systems, the valve shall be set to obtain the desired outlet pressure at the required water flow. According to UL Standard 1468 December 4, 2007, the minimum residual pressure for a valve intended for use in sprinkler system shall have a minimum residual pressure of 50 psi (354 kPa) for the ranges specified in the installation instructions



3- To determine the pressures at the hose nozzle or sprinkler, the hydraulic calculation information provided in NFPA 13 and the NFPA Fire Protection Handbook should be followed. In any case, the design flow demand required by the hose nozzle and/or sprinklers shall not exceed the flow range specified in the following performance charts.

4- The valves are designed and Listed to reduce inlet pressures of up to 400 PSIG to an outlet pressure range from 65 to 175 PSIG. Authorities having jurisdiction should be consulted to confirm that the outlet pressures and flowrates are acceptable.

5- To determine the proper valve setting to achieve the desired residual outlet pressure, consult the chart which is appropriate to the valve type (angle or straight) and the required flow rate. On that chart, identify on the horizontal axis the residual pressure at the valve inlet (Inlet Residual PSI). Where the vertical line from that Inlet Residual PSI figure intersects the curves on the graphs indicates the Outlet Residual PSI (vertical axis) to be achieved for the valve setting shown on each curve. For example, if an angle valve is used for a 250 GPM flow requirement, and the Inlet Residual PSI is 250, a valve setting of "100" will produce an outlet Residual PSI of 64, a setting of "140" will produce an Outlet Residual PSI of 98, and a setting of "175" will produce an Outlet Residual PSI of 125.

**Installation of 2 1/2" valve size**

For installation requirements refer to NFPA 13 for sprinkler systems or to NFPA 14 for Standpipe and hose systems. These valves are to be set to provide outlet pressures and flows end tested after installation in accordance with NFPA 13 and NFPA 14 whichever is applicable and tested periodically in accordance with NFPA 25.

- 1- Pipe unions or rubber-gasketed fittings are to be installed immediately upstream and downstream of the valve to permit easy replacement.
- 2- When a pressure reducing valve of this nature is installed, pressure can be trapped on the downstream side of the valve. In accordance with NFPA 13, when the valve is used in a sprinkler system, a relief valve of not less than 1/2 inch size is to be installed on the downstream side of the pressure reducing valve and pressure gauge are to be installed on the inlet and outlet sides of each pressure reducing valve.
- 3- Connect the valve to the piping, paying attention to follow the setting arrows that are cast into the valve which indicate the direction of flow.
- 4- To adjust the valve setting, a rod key (D/L 0.39/11.8 inch) which is included with the valve, shall be used. The rod key is to be inserted in the valve cylinder as indicated in the illustration on page #3. Refer to the graphs contained in these instructions and select the appropriate setting.
- 5- Rotate the cylinder with the rod key, until the desired setting is aligned with the indicating arrow on the valve.
- 6- The valve is now set. If the valve is intended to be open, check that the indicator reads "OPEN" and that the green cylinder, which appears above the setting zone, is in full view.
- 7- As the valve is automatic, the system must be flushed thoroughly to insure that all debris and impurities, are removed.
- 8- Upon completion of the hydrostatic test on the system, it is important that the system be slowly filled with water in order to prevent water hammer.

9- After installation the valve should be flow tested to determine that the desired residual pressure and flow are provided at the valve outlet. Such testing is required by NFPA 14, Section 8-5.

Note: flow testing at the hydraulically most remote location of the standpipe system will not permit calculation of residual valve outlet pressures at less remote locations equipped with pressure reducing valves

10- The rod key used to adjust the valve setting should be given to responsible personnel at the installation location, who should be instructed in its use if an emergency adjustment is necessary. The valve should also be tagged with information stating where the rod key can be located.

**Maintenance**

For inspection, testing and maintenance requirements of Water-Based Fire Protection Systems refer to NFPA 25.

- 1- It is recommended to conduct at least yearly a flow test to allow the valve to open and reset itself. After a flow test has been run, it is important all gauges be monitored to assure that the downstream pressure does not creep upward.
- 2- In the event the pressure does not hold, the test valve should be opened again to flush the valve.
- 3- The valve should be inspected for damage or corrosion and is not designed to accept replacement parts other than the hand wheel.
- 4- The valve should be operated by hand, never using a torque bar or other device to exert pressure. Excess torque may damage the seat and/or stem, disc, and other working parts.
- 5- If the valve fails to perform as intended, the valve should be replaced.



**Warning.**

Direction of water flow is to be as shown by the indicating arrow on the valve. Each valve is dispatched in conformity with the quality system after a complete test has been carried out.

**Function of the valves**

The side indicated by an arrow is the inlet and is connected to the upstream flow. The water passing through the seat creates a reduction in downstream pressure. The same seat is a check valve which does not allow a reverse flow from downstream to upstream: the spring keeps the valve closed when there is no water flow. The downstream pressure passes through a duct and reaches the first circular chamber. From this it flows into another duct, reaching the second chamber. The water pressure pushes the disc upwards. The force of the water pressure is counterbalanced by the force of spring. This spring is regulated by a graduated cylinder used for setting the valve. To set the valve on the cylinder the selected line must be level with the arrow. The models are UL Listed under categories Special System Control Valves Class I (VLFT) and Pressure Reducing Devices (VUTX).

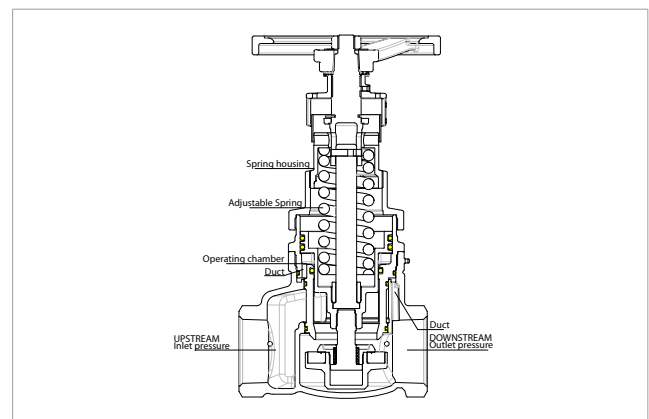



**Technical features**

The valves are designed and Listed to reduce inlet pressures of up to 400 PSIG to the range from 65 to 175 PSIG. The valves have a checking device.

Pipe unions or rubber-gasketed fittings are to be installed immediately upstream and downstream of the valve to permit easy replacement.\*



**\* Note.**

According to UL 1468, Dec.4, 2007 Par.9.4, „Valves intended for use in sprinkler systems shall have a minimum residual pressure of 50 psi for flow ranges specified in this leaflet“.

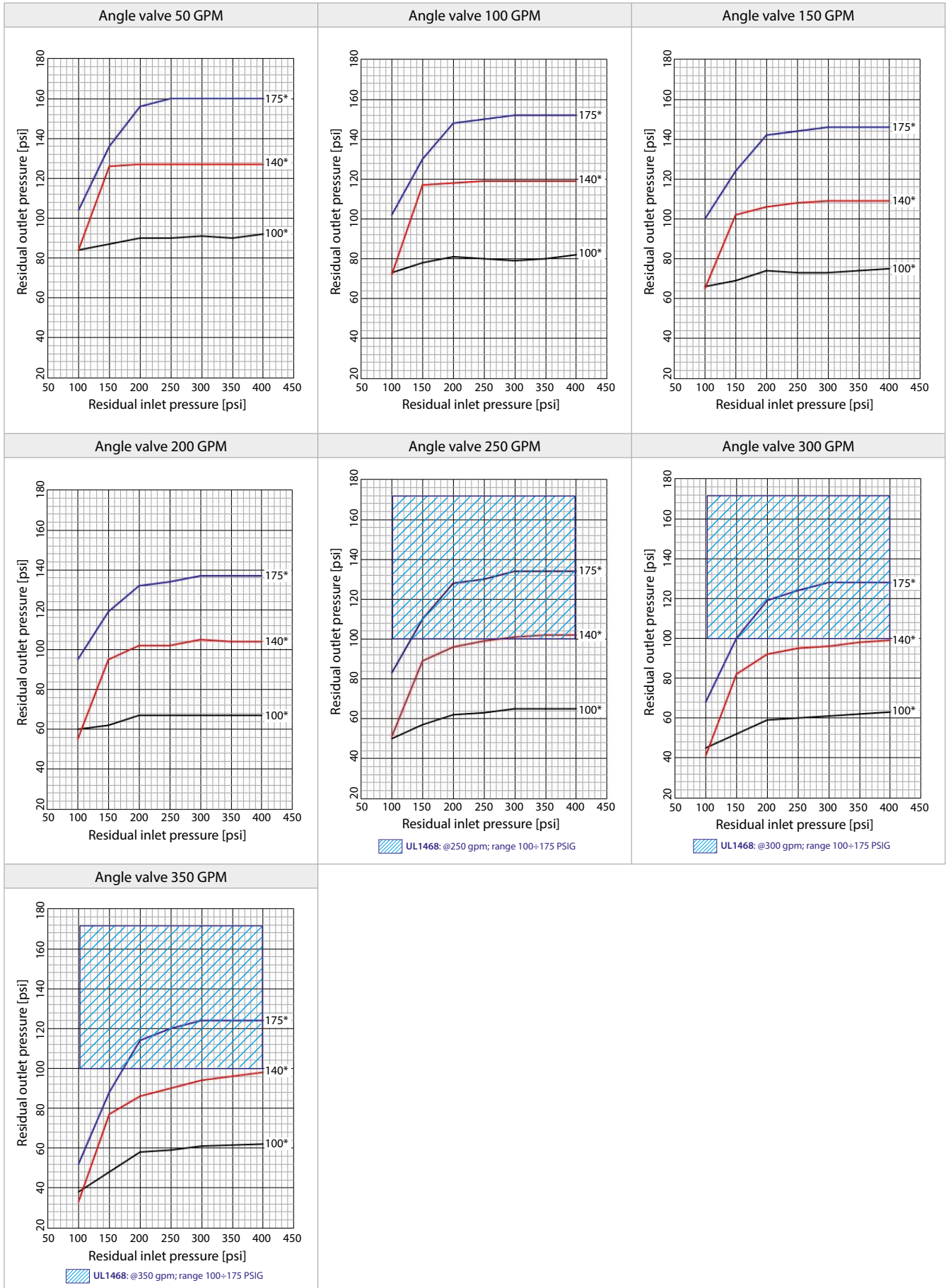



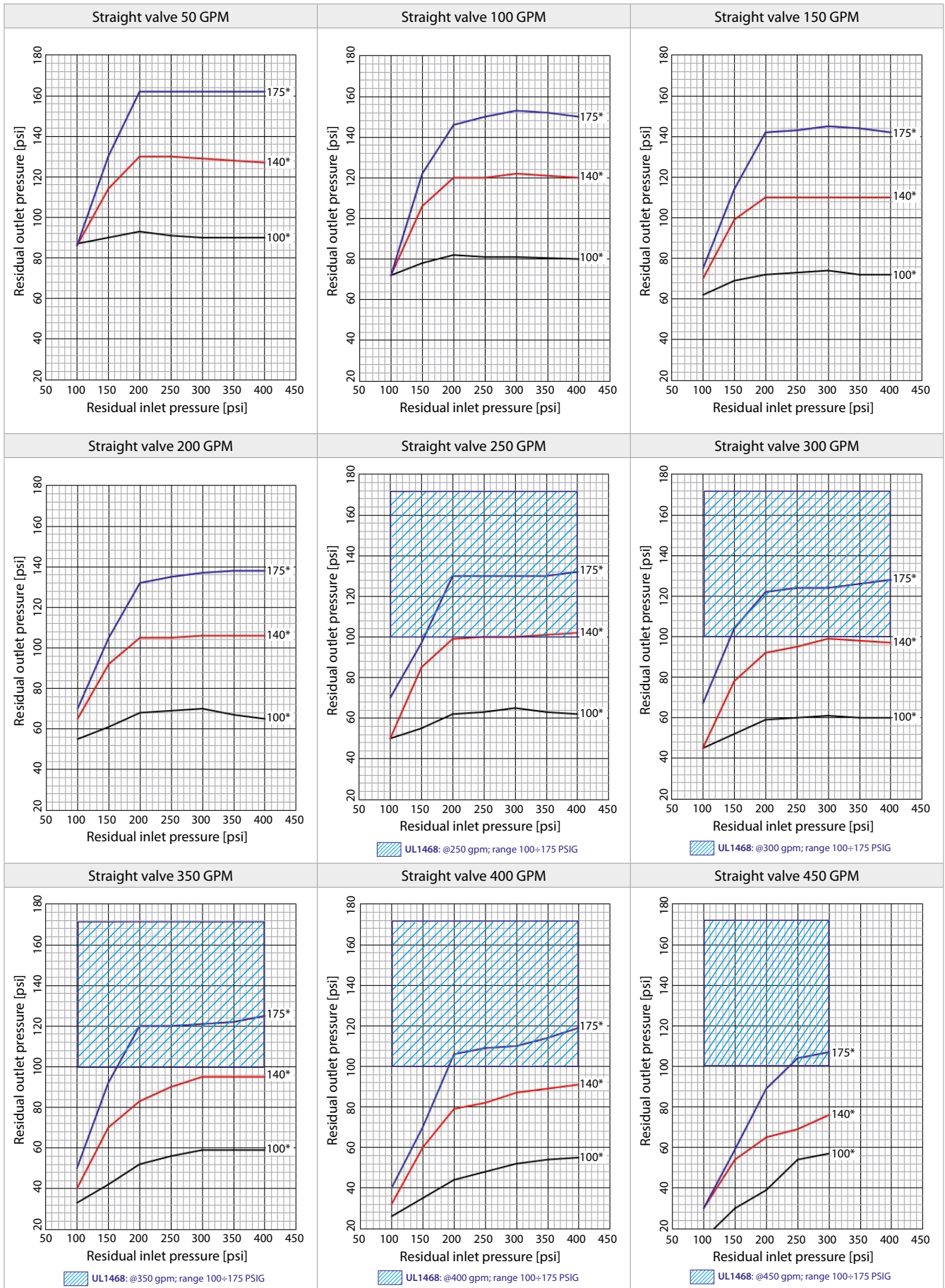

**i** \* Note.  
These valves are not outlet pressures or flows under residual flow conditions. They refer to the position for cylinder adjustment. They correspond to the approximate outlet pressure under zero-flow conditions.



**Caution**

The valves will produce the residual outlet pressure indicated on the graphs of these instructions only when the numerical values of the inlet pressure (for example, the "150" of 150 PSI inlet pressure) exceeds the numerical value of the valve setting.

When the numerical value of the inlet pressure is less than the numerical value of the valve setting, a substantial reduction in outlet pressure will be experienced because of friction losses with the valve.

In such a situation, the setting graphs in these instructions are inapplicable.

**Flow characteristics**

**Flow characteristic with inlet below setting at 50 PSIG and 125 PSIG inlet pressure while setting is 175**

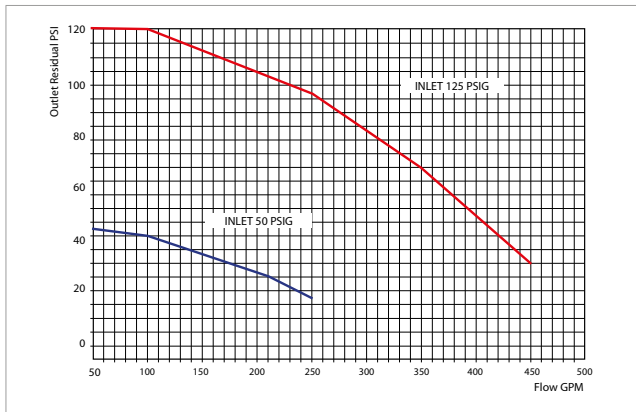

**Flow characteristics with inlet below setting at 40 PSIG and 50 PSIG inlet pressure while setting is 60**

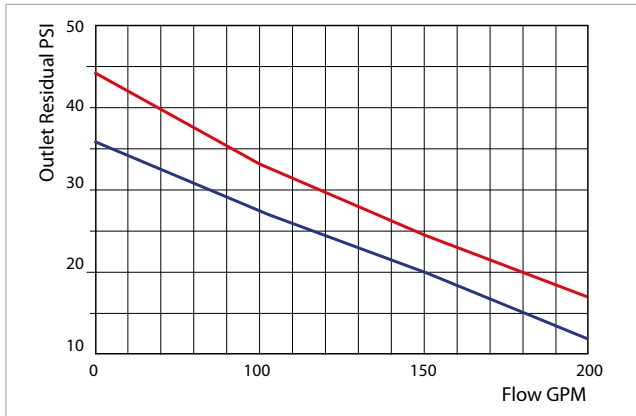

**Dimensions**

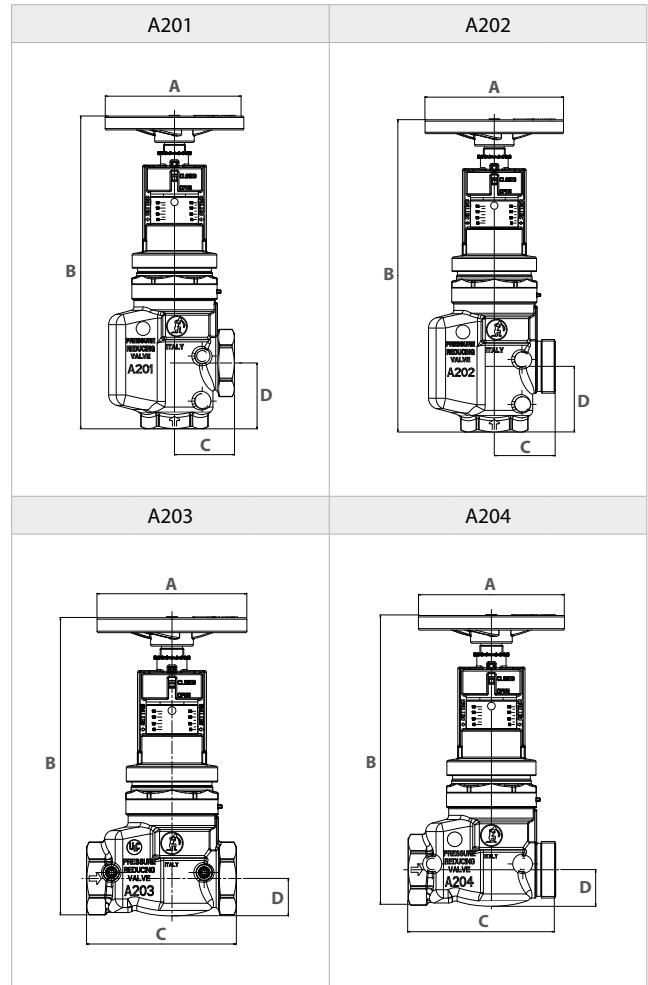

Series	Size	A	B	C	D
A201	2 1/2" x 2 1/2"	7 7/8"	18 1/4"	3 13/32"	3 3/4"
A202	2 1/2" x 2 1/2"	7 7/8"	18 1/4"	3 15/32"	3 3/4"
A203	2 1/2" x 2 1/2"	7 7/8"	15 13/16"	7 7/8"	1 31/32"
A204	2 1/2" x 2 1/2"	7 7/8"	15 13/16"	7 15/16"	1 31/32"



## Product specifications

### A201

Field adjustable pressure reducing female-female angle valve used as a zone control valve for in-line application to regulate high-pressure sprinkler, stand pipe and combined fire protection systems. The body is in casted bronze with 2 1/2" female NPT threads inlet and outlet. The handwheel is in red painted aluminum. Two side taps 1/4" NPT are for pressure gauges. An internal checking device improves the backflow preventer feature. The valve is used to regulate inlet pressure to 400 psi to a downstream pressure range of 65-175 psi; the valve is UL and ULC listed for 400 psi. An indicator bonnet shows whether valve is opened or closed; the adjustable scale permits easy field setting.

### A202

Field adjustable pressure reducing female-male angle valve used as a zone control valve for in-line application to regulate high-pressure sprinkler, stand pipe and combined fire protection systems. The body is in casted bronze with 2 1/2" female NPT inlet and 2 1/2" male hose thread outlet. The handwheel is in red painted aluminum. Two side taps 1/4" NPT are for pressure gauges. An internal checking device improves the backflow preventer feature. The valve is used to regulate inlet pressure to 400 psi to a downstream pressure range of 65-175 psi; the valve is UL and ULC listed for 400 psi. An indicator bonnet shows whether valve is opened or closed; the adjustable scale permits easy field setting.

### A203

Field adjustable pressure reducing female-female straight valve used as a zone control valve for in-line application to regulate high-pressure sprinkler, stand pipe and combined fire protection systems. The body is in casted bronze with 2 1/2" female NPT threads inlet and outlet. The handwheel is in red painted aluminum. Two side taps 1/4" NPT are for pressure gauges. An internal checking device improves the backflow preventer feature. The valve is used to regulate inlet pressure to 400 psi to a downstream pressure range of 65-175 psi; the valve is UL and ULC listed for 400 psi. An indicator bonnet shows whether valve is opened or closed; the adjustable scale permits easy field setting.

### A204

Field adjustable pressure reducing female-male straight valve used as a zone control valve for in-line application to regulate high-pressure sprinkler, stand pipe and combined fire protection systems. The body is in casted bronze with 2 1/2" female NPT inlet and 2 1/2" male hose thread outlet. The handwheel is in red painted aluminum. Two side taps 1/4" NPT are for pressure gauges. An internal checking device improves the backflow preventer feature. The valve is used to regulate inlet pressure to 400 psi to a downstream pressure range of 65-175 psi; the valve is UL and ULC listed for 400 psi. An indicator bonnet shows whether valve is opened or closed; the adjustable scale permits easy field setting.

## Additional information

For further information, visit the website [www.giacomini.com](http://www.giacomini.com) or contact the technical service: ☎ +39 0322 923372 📞 +39 0322 923255 ✉ [consulenza.prodotti@giacomini.com](mailto:consulenza.prodotti@giacomini.com)  
This information is intended as an example. Giacomini S.p.A. reserves the right to modify the contents - at any time and without prior warning - for technical or commercial reasons. The information in this technical sheet does not exempt the user from scrupulously observing the existing regulations and standards relating to good technical practices.  
Giacomini S.p.A. Via per Alzo, 39 - 28017 San Maurizio d'Opaglio (NO) Italy