

## ARTICULO: 2109

### Válvula de mariposa tipo wafer

### Butterfly valve wafer type

#### Características

1. Válvula de mariposa tipo wafer.
2. Cuerpo de fundición EN-GJL-200 (GG-20) para montaje entre bridas ANSI 150 y EN 1092 PN 10/16.
3. Elastómero de EPDM.
4. Disco de acero inoxidable 1.4408 (CF8M).
5. Brida montaje actuadores según ISO 5211.
6. Longitud entre caras según UNE EN 558-1 Serie 20 (DIN 3202 K1).
7. Recubrimiento con pintura Epoxi.
8. Temperatura de trabajo  $-20^{\circ}\text{C}$   $+120^{\circ}\text{C}$ .
9. Máxima presión de trabajo:  
16 bar (medidas 2" a 12")  
10 bar (medidas 14" a 24")

#### Features

1. Butterfly valve wafer type.
2. EN-GJL-200 (GG-20) CI body allows installation between ANSI 150 and EN 1092 PN 10/16 flanges.
3. EPDM body seat.
4. Disc made of Stainless Steel 1.4408 (CF8M).
5. Actuator mounting plate according to ISO 5211.
6. Face to face according to UNE EN 558-1 Series 20 (DIN 3202 K1).
7. Epoxy coating.
8. Working Temperature  $-20^{\circ}\text{C}$   $+120^{\circ}\text{C}$ .
9. Maximum working pressure:  
16 bar (sizes 2" to 12")  
10 bar (sizes 14" to 24")

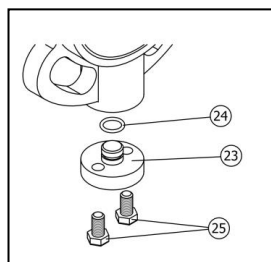
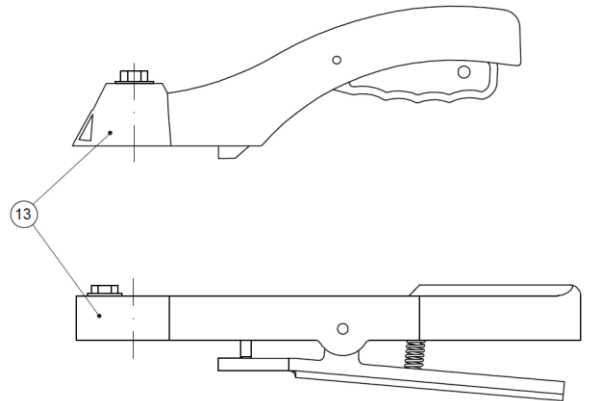
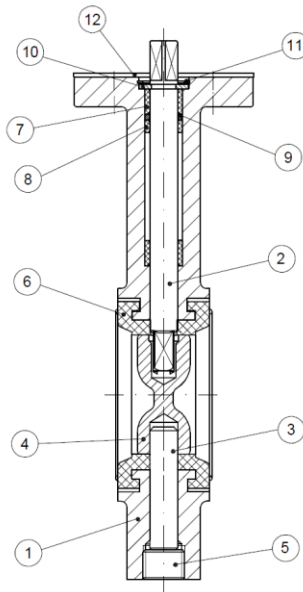

**Solamente /  
Only  $\geq 14''$**

N.	Denominación / Name	Material	Acabado Superficial / Surface Treatment	Cód. Recambio Spare Part Code
1	Cuerpo / Body	Fundición / Cast Iron EN-GJL-200	Pintado Epoxi / Epoxy Painted	-----
2	Eje / Stem	Acero Inox. / Stainless Steel AISI 416	-----	-----
3	Pivote / Pivot	Acero Inox. / Stainless Steel AISI 416 ( $\leq 12''$ )	-----	-----
4	Disco / Disc	Acero Inox. / Stainless Steel 1.4408 (CF8M)	Granallado / Shot blasting	-----
5	Tapón / Plug	Acero Carbono / Carbon Steel ( $\leq 12''$ )	Cincado / Zinc Plated	-----
6*	Elastómero / Seat	EPDM	-----	E2109
7	Casquillo / Bush	PTFE + Grafito / Graphite	-----	-----
8	Casquillo / Bush	PTFE + Grafito / Graphite	-----	-----
9	Tórica / O' ring	NBR	-----	-----
10	Arandela / Washer	Acero Carbono / Carbon Steel	Cincado / Zinc Plated	-----
11	Seguro / Stop Ring	Acero Carbono / Carbon Steel	Cincado / Zinc Plated	-----
12	Placa dentada / Plate	Acero Carbono / Carbon Steel	Cincado / Zinc Plated	-----
13	Palanca / Handle	Aluminio o Fundición EN-GJL-200 / Aluminium or Cast iron EN-GJL-200	Pintado Epoxi / Epoxy Painted	-----
23	Tapón /	Fundición / Cast Iron EN-GJL-200 ( $\geq 14''$ )	Pintado Epoxi / Epoxy Painted	-----
24	Tórica / O'ring	NBR ( $\geq 14''$ )	-----	-----
25	Tornillo / Bolt	Acero Carbono / Carbon Steel ( $\geq 14''$ )	Cincado / Zinc Plated	-----

\* Piezas de recambio disponibles / Available spare parts

## DIMENSIONES GENERALES / GENERAL DIMENSIONS

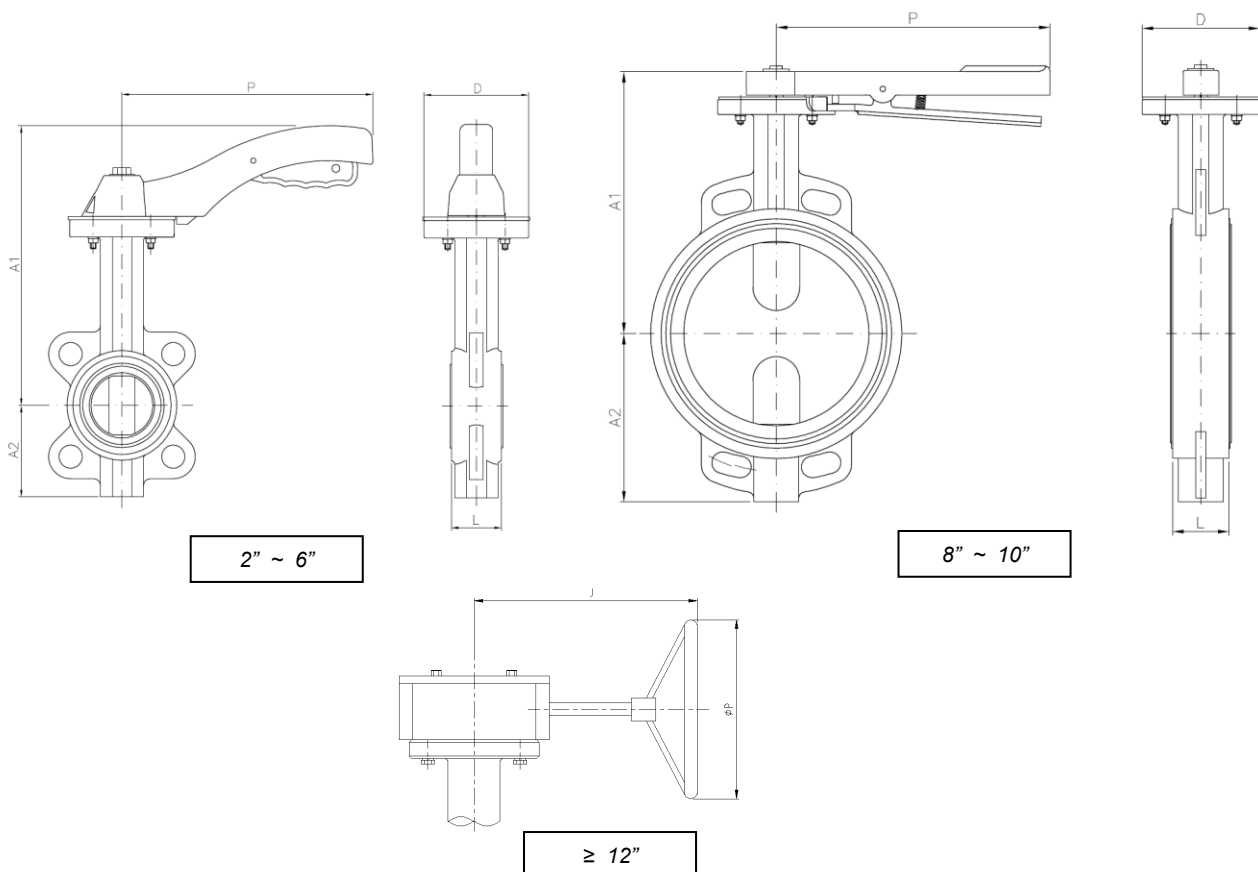

Ref.	Medida / Size	DN	PN	L	Dimensiones / Dimensions (mm)				Peso / Weight (kg)
					A1	A2	J	P	
2109 09	2"	50	16	43	238	70	***	170	2,800
2109 10	2 1/2"	65	16	46	238	80	***	170	3,300
2109 11	3"	80	16	46	238	100	***	170	3,800
2109 12	4"	100	16	52	270	115	***	215	5,800
2109 13	5"	125	16	56	300	135	***	215	7,400
2109 14	6"	150	16	56	300	150	***	215	8,350
2109 16	8"	200	16	60	280	180	***	300	14,400
2109 18	10"	250	16	68	330	215	***	300	21,800
2109 20	12"	300	16	78	360	250	240	290	38,800
2109 22	14"	350	10	78	390	260	257	290	56,100
2109 24	16"	400	10	102	420	300	257	290	77,600
2109 26	18"	450	10	114	445	330	306	400	115,500
2109 28	20"	500	10	127	480	370	306	400	144,500
2109 32	24"	600	10	152	710	467	342	400	243,000

\*\*\* Nota: De 2" a 6" Maneta de aluminio / From 2" to 6" Aluminium handle.  
De 8" a 10" Maneta de fundición de hierro / From 8" to 10" cast iron handle.  
A partir de 12" operación mediante reductor manual / From 12", handling by gear box.

### Dimensiones de brida superior / Top flange dimensions:

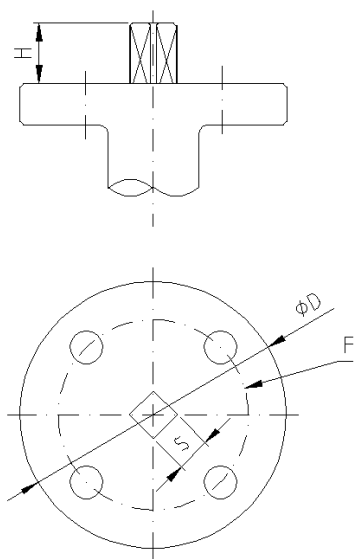

Top flange dimensions						
Article	DN	F (ISO5211)	S	D	H	Torque N·m
2109 09	50	F05	11	65	16	12
2109 10	65	F05	11	65	16	20
2109 11	80	F05	11	65	16	27
2109 12	100	F07	14	90	16	39
2109 13	125	F07	14	90	16	58
2109 14	150	F07	14	90	16	90
2109 16	200	F07/F10	17	125	28	120
2109 18	250	F10	22	125	28	180
2109 20	300	F10/F12	22	150	28	340
2109 22	350	F12	22	150	45	640
2109 24	400	F14	27	175	45	805
2109 26	450	F14	27	175	45	1100
2109 28	500	F14	36	175	45	1500
2109 32	600	F16	Ø 50,65	210	70	2500

**Perdidas de Carga ( Kv ) según posición del disco / Head losses according to disc position:**

DN	Posición del Disco (grados) / Disc Position (degrees)								
	90°	80°	70°	60°	50°	40°	30°	20°	10°
50	125	99	73	53	37	23	14	6	0,9
65	244	193	141	93	58	37	21	10	1,3
80	399	315	231	133	83	53	30	13	1,7
100	727	606	429	237	148	94	54	23	2,6
125	1190	991	670	370	232	147	85	37	4
150	1600	1334	887	490	306	195	112	48	5
200	2868	2458	1611	935	588	364	208	88	10
250	4697	3914	2550	1479	931	577	330	140	16
300	6987	5822	3800	2217	1379	869	480	203	23
350	9115	7676	5137	2927	1859	1142	654	259	29
400	12081	10173	6805	3878	2463	1513	866	343	39
450	14890	12539	8706	4962	3151	1935	1108	439	50
500	19323	16272	10843	6180	3924	2410	1380	547	62
600	37295	33939	22626	14297	8640	4848	2238	1057	130

**VALORES DE Kv / Kv VALUES**

Kv = Es la cantidad de metros cúbicos por hora (m<sup>3</sup>/h) que pasará a través de la válvula generando una pérdida de carga de 1 bar.

*Kv = Flow rate of water in cubic meter per hour (m<sup>3</sup>/h) that will generate a pressure drop of 1 bar across the valve.*

**VALORES DE Cv / Cv VALUES**

Cv = Es la cantidad de galones por minuto (gpm) que pasará a través de la válvula generando una pérdida de carga de 1 psi.

*Cv = Flow rate of water (g.p.m.) which generates a pressure drop of 1 psi across the valve.*

<b><math>Cv = 1,156 \cdot Kv</math></b>
---

**Medidas de Precaución para la instalación / Caution measures for Installation:**

1. No instale la válvula en posición totalmente cerrada / *Do not install the butterfly valve in total closed position.*
2. Verifique el buen paralelismo de las bridas / *Check the good parallelism of the flanges.*
3. No coloque otras juntas entre las bridas / *Do not insert other gaskets between flange and valve.*
4. Abra totalmente la válvula antes de apretar las bridas / *Open completely the valve before tightening flanges.*

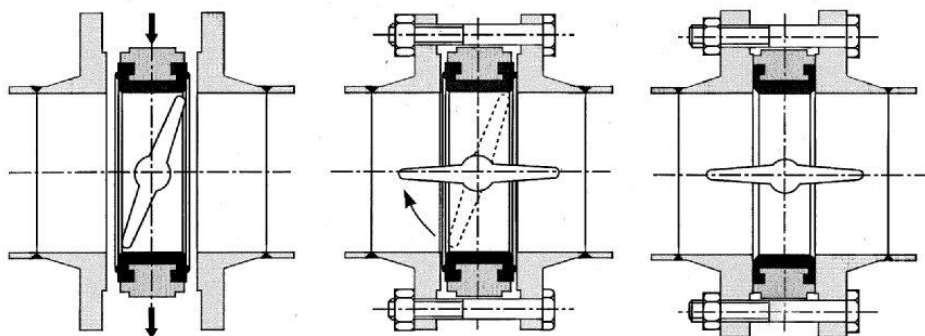

## CURVA PRESION TEMPERATURA / *PRESSURE TEMPERATURE RATING*

